



Mass Casualty Incidenten

Vincent Peters

Ambulanceverpleegkundige





Mass Casualty Incidenten

Concert Ariana Grande
Manchester 2017





Mass Casualty Incidenten



Love Parade
Duisburg 2010





Mass Casualty Incidenten

Aanslagen in Europa in 2018



28 maart 2018 – Carcassonne en Trebes – Frankrijk

4  1  Dader is eveneens om het leven gekomen



7 april 2018 – Munster – Duitsland

4  30  Dader is eveneens om het leven gekomen

7 mei 2018 – Den Haag – Nederland

0  3  Dader is eveneens om het leven gekomen



12 mei 2018 – Parijs – Frankrijk

1  4  Dader is eveneens om het leven gekomen





Mass Casualty Incidenten

29 mei 2018 – Luik – België

3  0  Dader is eveneens om het leven gekomen



20 juli 2018 – Lubeck – Duitsland

0  14  Dader is eveneens om het leven gekomen

31 augustus – Amsterdam – Nederland

0  2  Dader is gewond geraakt en gearresteerd

11 december 2018 – Straatsburg – Frankrijk

5  11  Dader is eveneens om het leven gekomen



Mass Casualty Incidenten



Dreigingsniveau in
Nederland

-> 4 substantieel

- Wapens
- Voertuigen
- Explosieven



Mass Casualty Incidenten



Luchthaven Zaventem
22 maart 2016

Mass Casualty Incidenten



Primair blast injuries

Verwondingen die door de drukgolf worden veroorzaakt

Secundairy blast injuries

Verwondingen die door fragmentatie van het explosief worden veroorzaakt

Tertiary blast injuries

Verwonding die worden veroorzaakt door verplaatsen lichaam of omgeving (vnl stomp trauma door val)

Quaternary blast injuries

Brandwonden, toxines, radiologische besmetting

Mass Casualty Incidenten

Combat Fatality Rate (percentage wat overlijdt)

- WOII 19,1%
- Vietnam 15,8 %
- Afghanistan 9,4%

Letsel

- 85% bloeding
- 14% airway
- 09% hersenletsel
- 04% orgaanfalen



Mass Casualty Incidenten



WARNING



Mass Casualty Incidenten



Mass Casualty Incidenten



Mass Casualty Incidenten



Boston Marthon
April 2013



Mass Casualty Incidenten



Geen materiaal beschikbaar?



Mass Casualty Incidenten



Mass Casualty Incidenten



- Situatie awareness
- Go, but stay low
- Herken potentieel letsel
- Oorzaken effectief en agressief behandelen
- "Do the most for the most"



Mass Casualty Incidenten

MARCH

M (massive bleeding)

- *Tourniquets en hemostatisch verband*

A (airway)

- *Zijligging en nasale tubes*

R (respiration)

- *Chest seal*

C (circulation)

- *Beoordelen hemodynamische status en medicatie*

H (head/hypothermie)

- *Alu deken*



CABC?





Mass Casualty Incidenten

Massive bleeding

Holk methodiek

- **H**als
- **O**ksels
- **L**iezen
- **K**nieholtes



Mass Casualty Incidenten

Massive bleeding



Mass Casualty Incidenten

Airway



Mass Casualty Incidenten

Respiration



Mass Casualty Incidenten

Circulation





Mass Casualty Incidenten

Shock

Risicofactoren shock:

- Leeftijd
- Medicatie
- Ernst verwonding
- Tijdsduur tot hulp
- Tijdsduur shock
- Gegeven hoeveelheid infuusvloeistof



Mass Casualty Incidenten

Hypothermie



Mass Casualty Incidenten

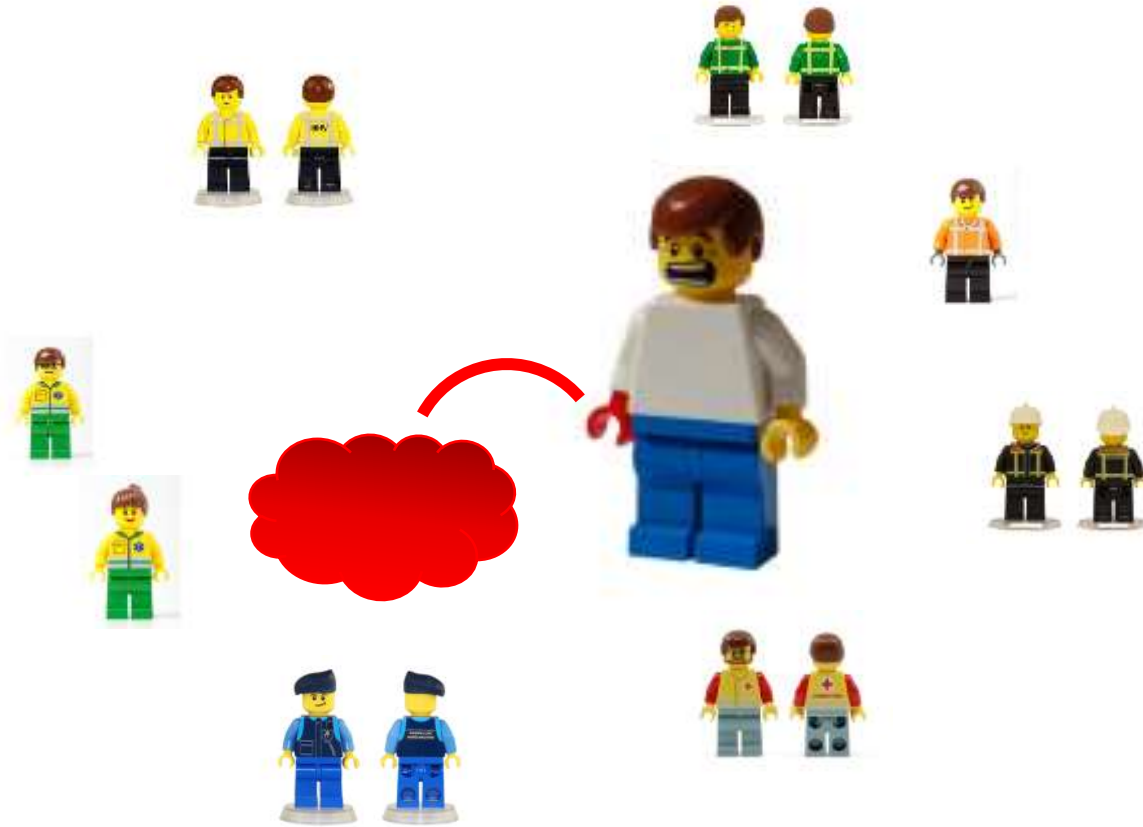

Mass Casualty Incidenten



Is het veilig?



Mass Casualty Incidenten



Triage



Mass Casualty Incidenten

Major Incident Medical Management and Support (MIMMS)
London Bombings – 7 juli 2005



Mass Casualty Incidenten



Triage is gebaseerd op ABCDE methodiek

Principes ABCDE

- Complete beoordeling van het slachtoffer doormiddel van vaste structuur en prioriteiten.
- Diagnose is hierbij niet belangrijk, behandeling van levensbedreigende problemen wel.



Mass Casualty Incidenten

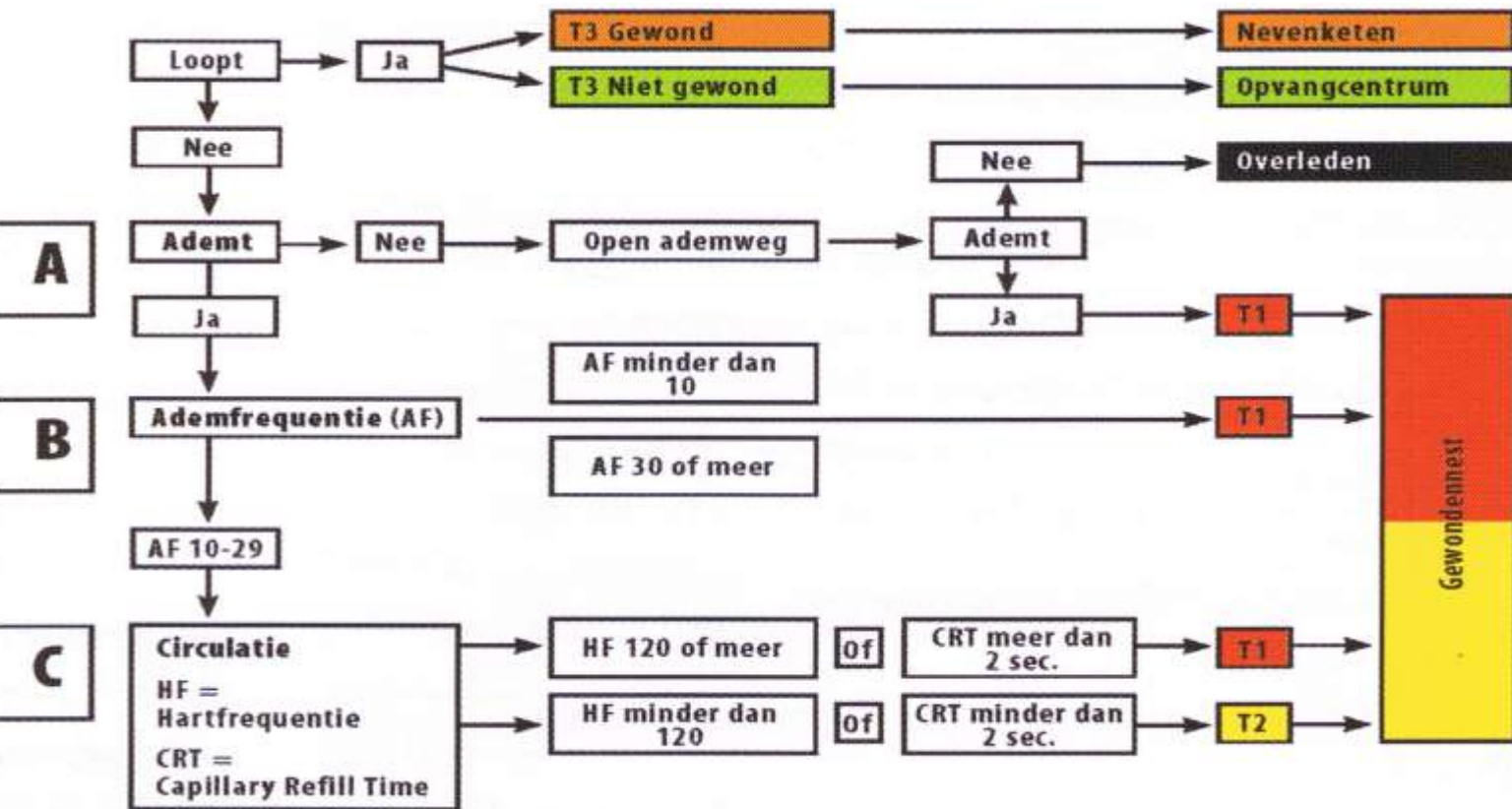

Mass Casualty Incidenten



Nieuw triagesysteem

Mass Casualty Incidenten



Rolverdeling Grootschalige Geneeskundige Bijstand



- Taakverantwoordelijke Comand & Control

- Taakverantwoordelijke triage



- Taakverantwoordelijke treatment

- Taakverantwoordelijke secundaire triage



Mass Casualty Incidenten

Vragen?



Mass Casualty Incidenten



Dank voor u aandacht....